

788系列推拉窗结构图(75)

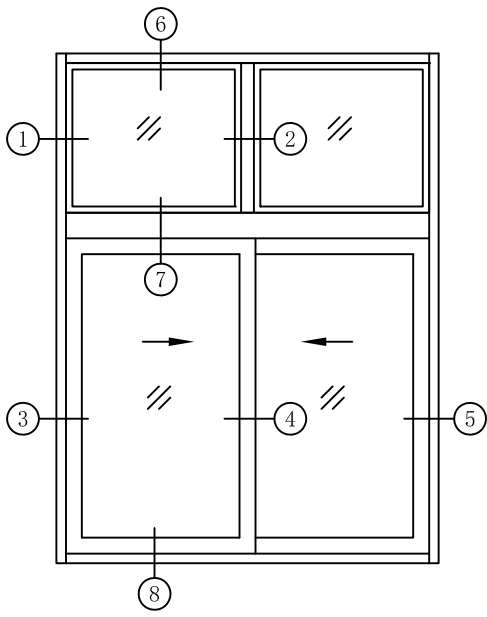

标准窗: 1.5mX1.5m, 耗材约4.9kg/m²。

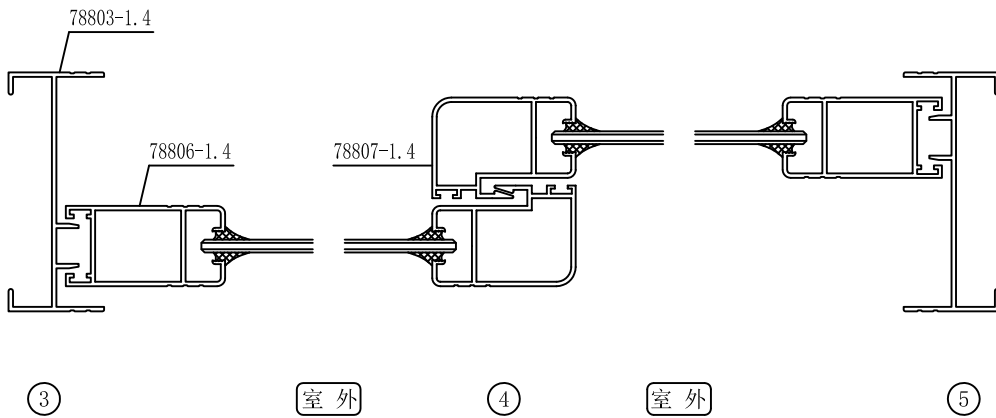
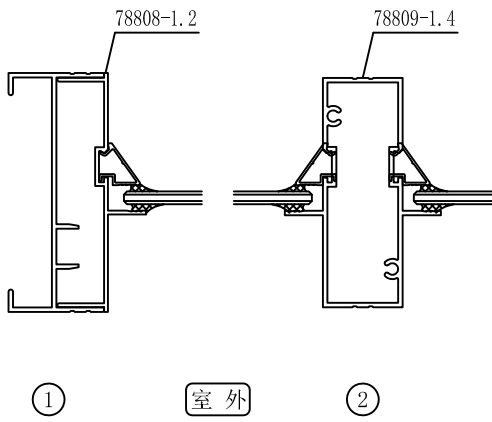
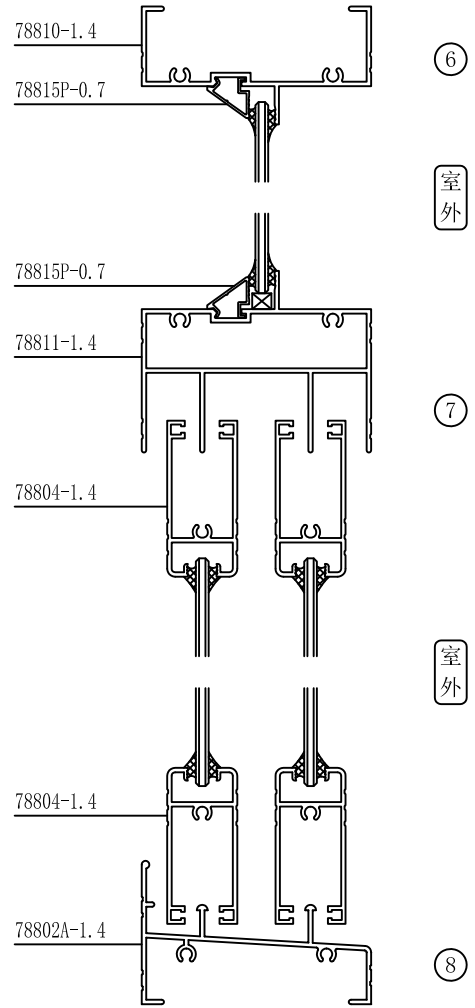

788系列推拉窗结构图(80)

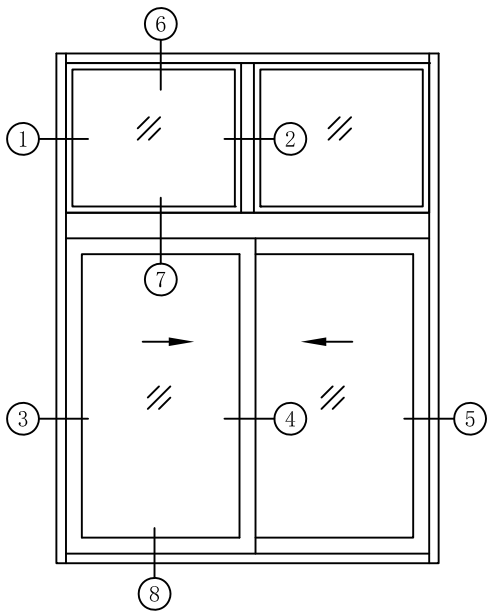



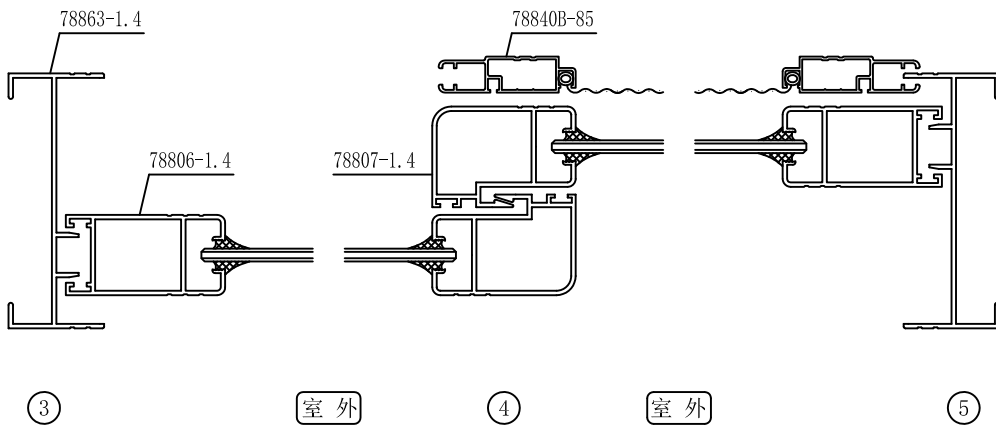
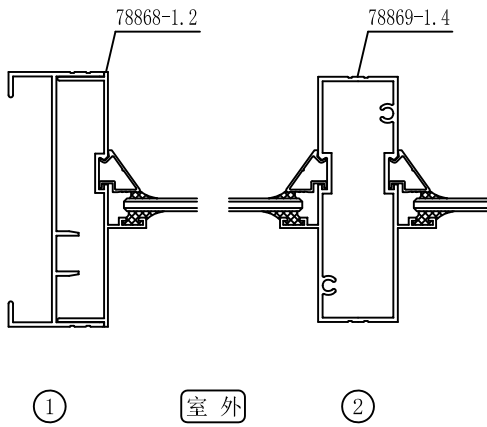
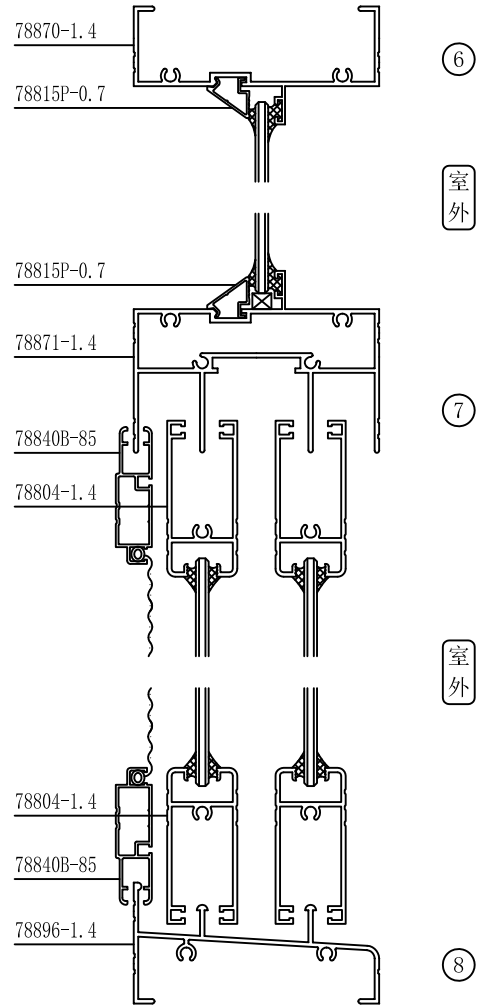

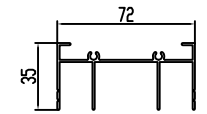
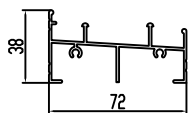
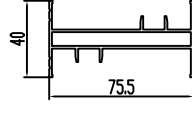
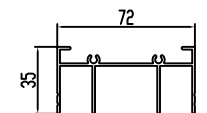
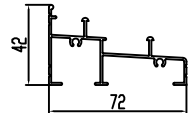
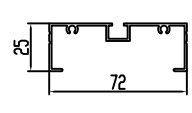
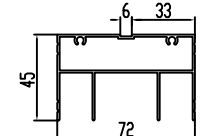
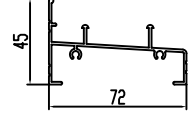
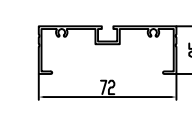
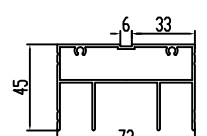
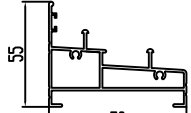
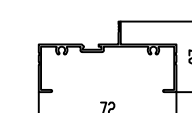
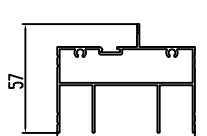
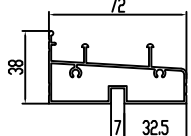
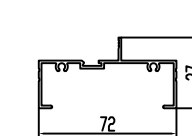
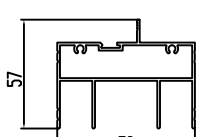
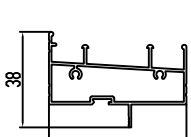
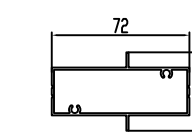
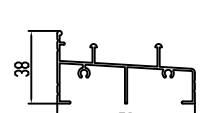
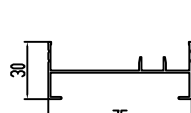
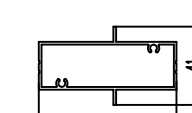
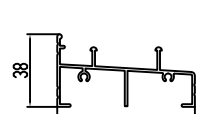
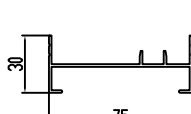
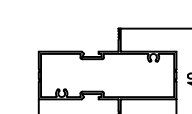

标准窗: 1.5mX1.5m, 耗材约5.5kg/m²。

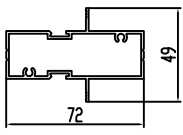

788系列推拉窗型材目录(75)

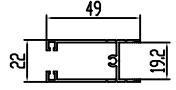
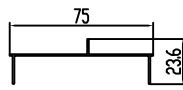
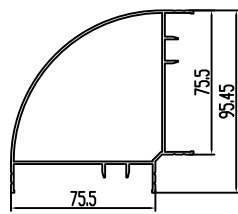
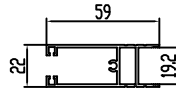
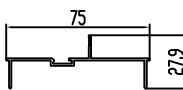
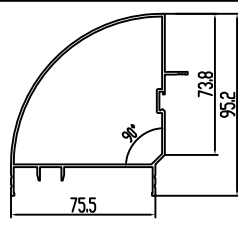
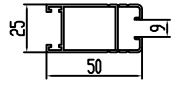
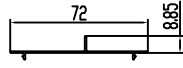
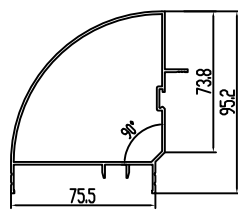
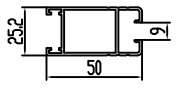
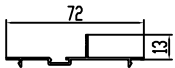
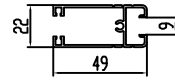
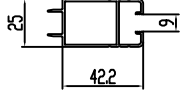
型材编号	图 例	型材编号	图 例	型材编号	图 例
名称		名称		名称	
壁厚T(mm)		壁厚T(mm)		壁厚T(mm)	
重量(kg/m)		重量(kg/m)		重量(kg/m)	
78801-1.2 上滑 T=1.2 0.705 kg/m		78824-1.4 下滑 T=1.4 0.815 kg/m		78833-1.4 双边企 T=1.4 0.948 kg/m	
78801-1.4 上滑 T=1.4 0.818 kg/m		78812A-1.2 下滑 T=1.2 0.691 kg/m		78820-1.2 上固 T=1.2 0.543 kg/m	
78821-1.2 固上滑 T=1.2 0.961 kg/m		78802A-1.4 下滑 T=1.4 0.718 kg/m		78820-1.4 上固 T=1.4 0.624 kg/m	
78821-1.4 固上滑 T=1.4 1.110 kg/m		78889-1.4 下滑 T=1.4 1.088 kg/m		78810-1.2 上固 T=1.2 0.540 kg/m	
78811-1.2 固上滑 T=1.2 1.013 kg/m		788253 固下滑 T=1.2 0.851 kg/m		78810-1.4 上固 T=1.4 0.626 kg/m	
78811-1.4 固上滑 T=1.4 1.179 kg/m		78822-1.4 固下滑 T=1.4 1.048 kg/m		78819-1.15 中柱 T=1.15 0.691 kg/m	
78802-1.2 下滑 T=1.2 0.672 kg/m		78803-1.2 边企 T=1.2 0.505 kg/m		78819-1.4 中挺 T=1.4 0.829 kg/m	
78802-1.4 下滑 T=1.4 0.761 kg/m		78803-1.4 边企 T=1.4 0.583 kg/m		78809-1.2 中挺 T=1.2 0.788 kg/m	

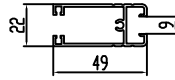
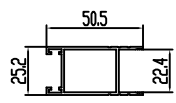
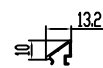
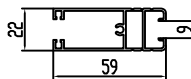
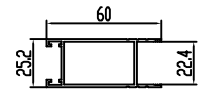
788系列推拉窗型材目录(75)

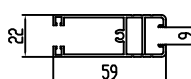
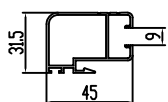
型材编号	图 例	型材编号	图 例	型材编号	图 例
名称		名称		名称	
壁厚T(mm)		壁厚T(mm)		壁厚T(mm)	
重量(kg/m)		重量(kg/m)		重量(kg/m)	
78809-1.4 中挺 T=1.4 0.918 kg/m		78891P-0.8 压线 T=0.8 0.054 kg/m		78834-14 中空上下方 T=1.4 0.518 kg/m	
78818-0.85 边封插板 T=0.85 0.256 kg/m		78816-1.4 90° 转角 T=1.4 1.380 kg/m		78835-14 中空高下方 T=1.4 0.667 kg/m	
78808-1.2 边封插板 T=1.2 0.396 kg/m		78826-1.4 90° 转角 T=1.4 1.283 kg/m		78806-1.2 光企 T=1.2 0.551 kg/m	
78865 下滑反插板 T=0.85 0.203 kg/m		78827-1.4 90° 转角 T=1.4 1.285 kg/m		78806-1.4 光企 T=1.4 0.623 kg/m	
78814-1.0 下滑反插板 T=1.0 0.267 kg/m		78804-1.2 上下方 T=1.2 0.513 kg/m		78806E-12 收口光企 T=1.2 0.521 kg/m	
78815-0.8 压线 T=0.8 0.081 kg/m		78804-1.4 上下方 T=1.4 0.569 kg/m		78836-14 光企 T=1.4 0.570 kg/m	
78815P-0.7 压线 T=0.7 0.075 kg/m		78805-1.2 高下方 T=1.2 0.643 kg/m		78836A-14 中空光企 T=1.4 0.640 kg/m	
78891-0.8 压线 T=0.8 0.057 kg/m		78805-1.4 高下方 T=1.4 0.724 kg/m		78807-1.2 勾企 T=1.2 0.578 kg/m	

喷涂专用
槽口: 20MM

注: 仅适用于1.2厚度型材



注: 仅适用于1.2厚度型材

槽口: 80MM

喷涂专用
槽口: 80MM

槽口: 20MM

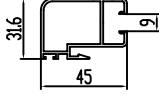
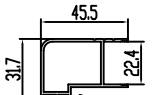
788系列推拉窗型材目录(75)

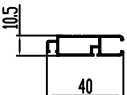
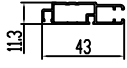
型材编号	图 例	型材编号	图 例	型材编号	图 例
名称		名称		名称	
壁厚T(mm)		壁厚T(mm)		壁厚T(mm)	
重量(kg/m)		重量(kg/m)		重量(kg/m)	
78807-1.4 勾企 T=1.4 0.658 kg/m					
78837-14 勾企 T=1.4 0.605 kg/m					
78823-1.15 收口 T=1.15 0.388 kg/m					
78840-0.7 纱窗 T=0.7 0.207 kg/m					
78840B-85 纱窗 T=0.85 0.274 kg/m					

788系列推拉窗型材目录(80)

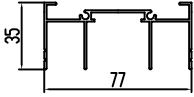
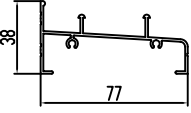
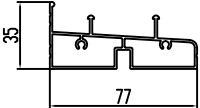
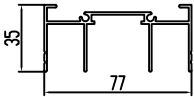
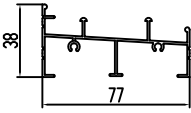
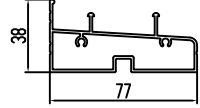
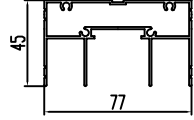
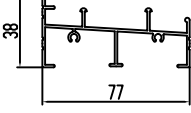
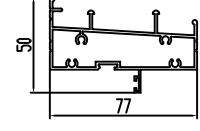
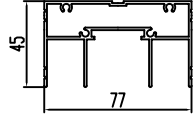
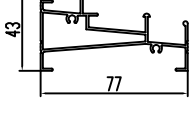
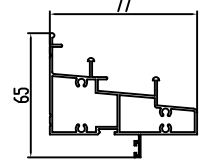
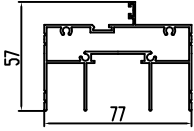
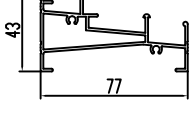
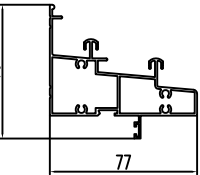
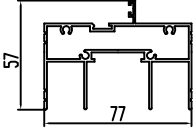
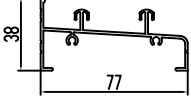
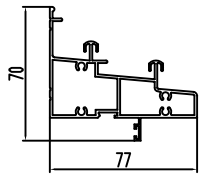
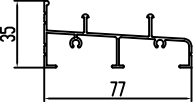
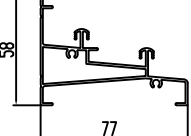
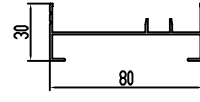
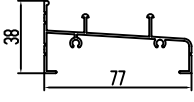
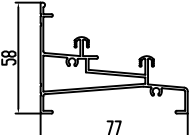
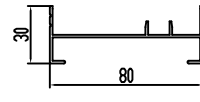
型材编号	图 例	型材编号	图 例	型材编号	图 例
名称		名称		名称	
壁厚T(mm)		壁厚T(mm)		壁厚T(mm)	
重量(kg/m)		重量(kg/m)		重量(kg/m)	
78861-1.2 上滑 T=1.2 0.739 kg/m		78896-1.4 下滑 T=1.4 0.691 kg/m		788263 固下滑 T=1.2 0.892 kg/m	
78861-1.4 上滑 T=1.4 0.850 kg/m		78862-1.2 下滑 T=1.2 0.739 kg/m		788250 固下滑 T=1.4 0.989 kg/m	
78881-1.2 固上滑 T=1.2 1.071 kg/m		78862-1.4 下滑 T=1.4 0.837 kg/m		78882-1.4 固下滑 T=1.4 1.131 kg/m	
78881-1.4 固上滑 T=1.4 1.231 kg/m		78872-1.2 下滑 T=1.2 0.888 kg/m		788119-12 固下滑 T=1.2 0.877 kg/m	
78871-1.2 固上滑 T=1.2 1.144 kg/m		78872-1.4 下滑 T=1.4 1.015 kg/m		788168-12 固下滑 T=1.2 1.196 kg/m	
78871-1.4 固上滑 T=1.4 1.306 kg/m		788178-14 下滑 T=1.4 0.753 kg/m		788168-14 固下滑 T=1.4 1.318 kg/m	
788120-12 下滑 T=1.2 0.670 kg/m		788169-12 下滑 T=1.2 0.964 kg/m		78863-1.2 边企 T=1.2 0.526 kg/m	
78896-1.2 下滑 T=1.2 0.613 kg/m		788169-14 下滑 T=1.4 1.077 kg/m		78863-1.4 边企 T=1.4 0.610 kg/m	

788系列推拉窗型材目录(80)

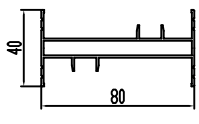
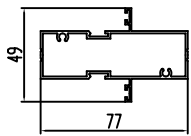
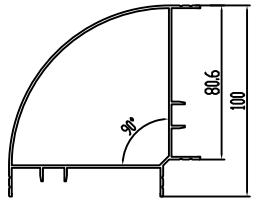
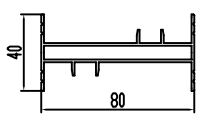
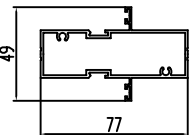
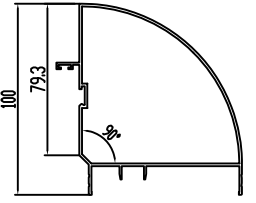
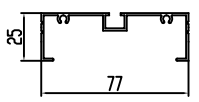
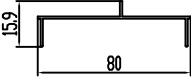
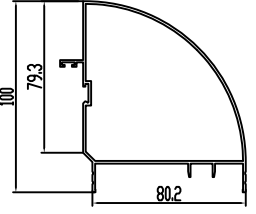
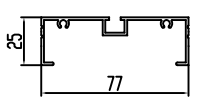
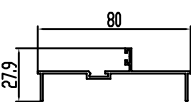
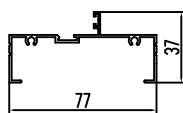
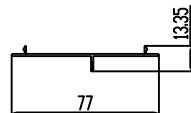
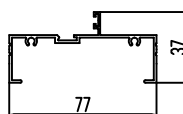
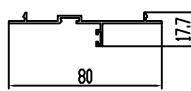
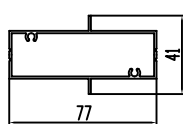
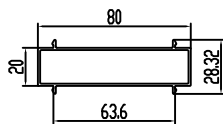
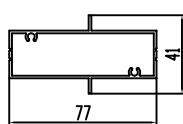
型材编号	图 例	型材编号	图 例	型材编号	图 例
名称		名称		名称	
壁厚T(mm)		壁厚T(mm)		壁厚T(mm)	
重量(kg/m)		重量(kg/m)		重量(kg/m)	
78873-1.2 双边封 T=1.2 0.839 kg/m		78869-1.2 中固 T=1.2 0.855 kg/m		78876-1.4 90° 转角 T=1.4 1.444 kg/m	
78873-1.4 双边封 T=1.4 0.974 kg/m		78869-1.4 中固 T=1.4 0.966 kg/m		78886-14 90° 转角 T=1.4 1.358 kg/m	
78880-1.2 上固 T=1.2 0.556 kg/m		78878-1.2 插板 T=1.2 0.378 kg/m		78887-14 90° 转角 T=1.4 1.358 kg/m	
78880-1.4 上固 T=1.4 0.634 kg/m		78868-1.2 插板 T=1.2 0.429 kg/m			
78870-1.2 上固 T=1.2 0.569 kg/m		78893A-12 下滑插板 T=1.2 0.298 kg/m			
78870-1.4 上固 T=1.4 0.642 kg/m		788239 边封反插板 T=1.2 0.369 kg/m			
78879-1.2 中柱 T=1.2 0.750 kg/m		788222B 拼管 T=1.2 0.702 kg/m			
78879-1.4 中柱 T=1.4 0.864 kg/m		78876-1.2 90° 转角 T=1.2 1.257 kg/m	