

ZYT990A系列推拉门窗结构图

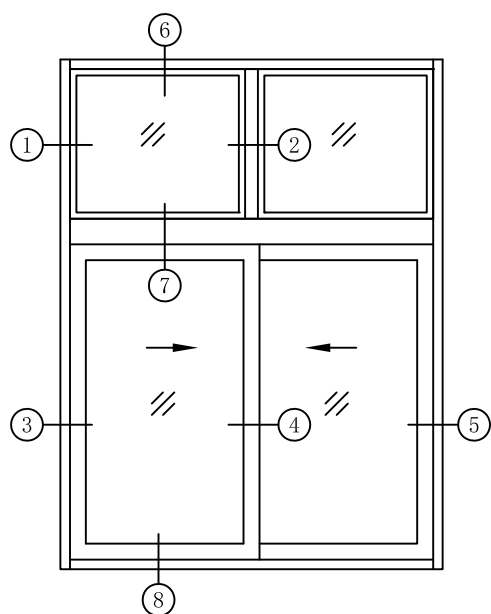

标准窗: 1.5mX1.5m, 耗材约5.8kg/m²。

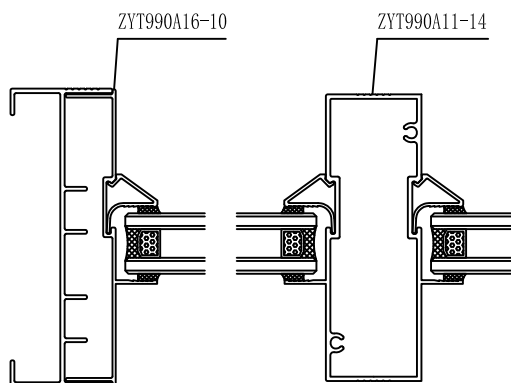
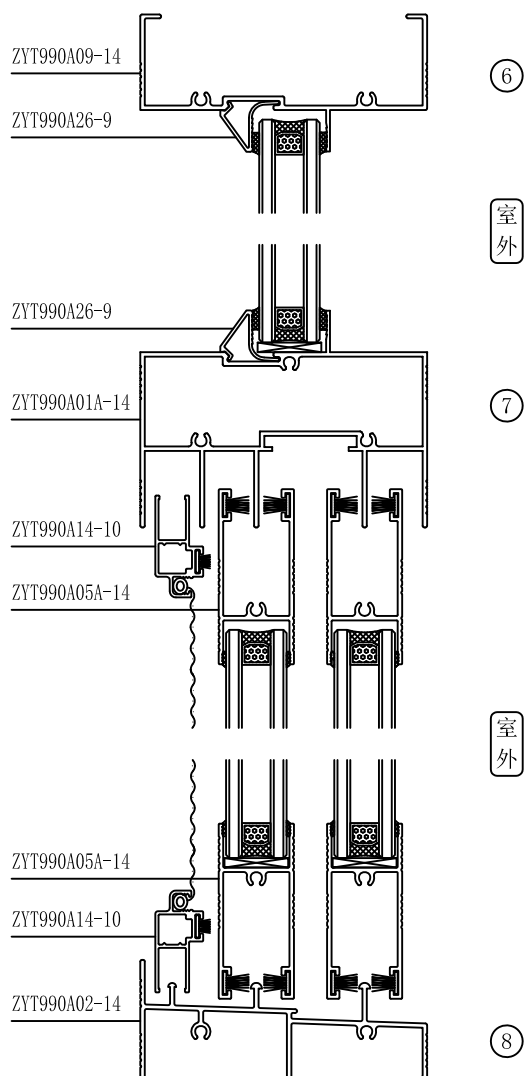

① 室外

②

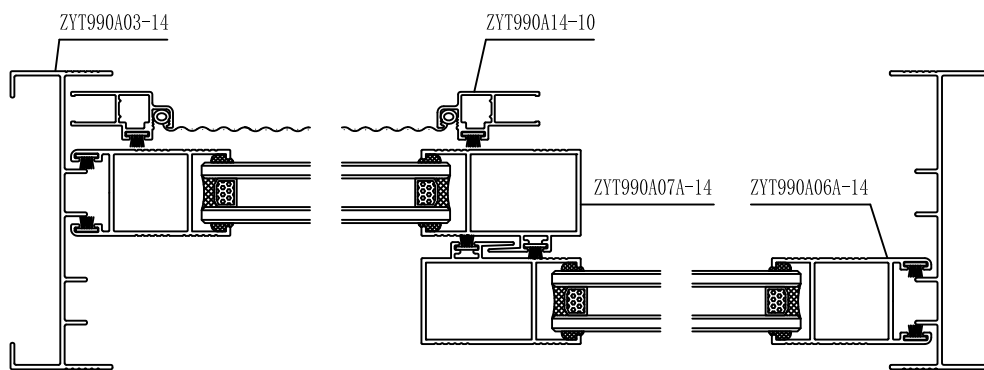

③

室外

④



室外

⑤

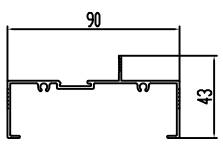
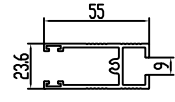
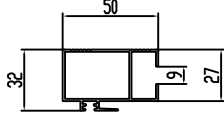
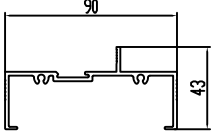
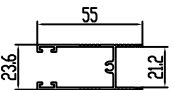
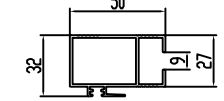
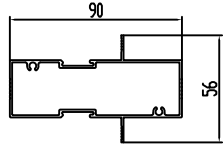
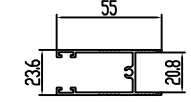
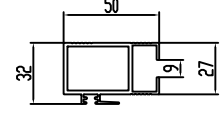
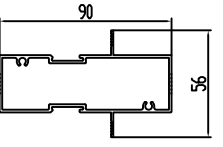
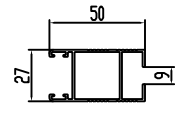
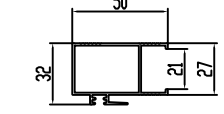
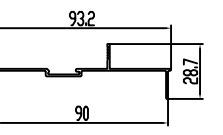
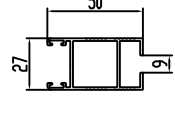
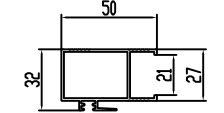
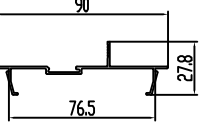
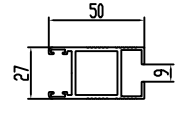
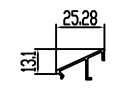
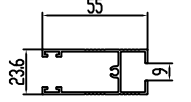
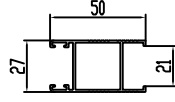
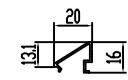
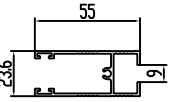
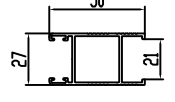

ZYT990A系列推拉门窗型材目录

型材编号	图 例	型材编号	图 例	型材编号	图 例
名称		名称		名称	
壁厚T(mm)		壁厚T(mm)		壁厚T(mm)	
重量(kg/m)		重量(kg/m)		重量(kg/m)	
ZYT990A01-12		ZYT990A02-20		ZYT990A20-14	
上滑 T=1.2 0.942 kg/m		下滑 T=2.0 1.136 kg/m		固下滑 T=1.4 1.365 kg/m	
ZYT990A01-14		ZYT990A18-12		ZYT990A24	
上滑 T=1.4 1.084 kg/m		宽轨下滑 T=1.2 0.865 kg/m		固下滑 T=1.4 1.453 kg/m	
ZYT990A01-20		ZYT990A18-14		ZYT990A03-12	
上滑 T=2.0 1.471 kg/m		宽轨下滑 T=1.4 0.980 kg/m		边封 T=1.2 0.639 kg/m	
ZYT990A01A-12		ZYT990A02B-14		ZYT990A03-14	
固上滑 T=1.2 1.354 kg/m		宽轨下滑 T=1.4 1.060 kg/m		边封 T=1.4 0.723 kg/m	
ZYT990A01A-14		ZYT990A19-20		ZYT990A03-20	
固上滑 T=1.4 1.548 kg/m		宽轨门下滑 T=2.0 1.239 kg/m		边封 T=2.0 0.991 kg/m	
ZYT990A01A-20		ZYT990A02A-12		ZYT990A15-12	
固上滑 T=2.0 2.124 kg/m		固下滑 T=1.2 1.106 kg/m		双边封 T=1.2 1.065 kg/m	
ZYT990A02-12		ZYT990A02A-14		ZYT990A15-14	
下滑 T=1.2 0.764 kg/m		固下滑 T=1.4 1.248 kg/m		双边封 T=1.4 1.242 kg/m	
ZYT990A02-14		ZYT990A20-12		ZYT990A09-12	
下滑 T=1.4 0.863 kg/m		固下滑 T=1.2 1.207 kg/m		固定框 T=1.2 0.647 kg/m	

ZYT990A系列推拉门窗型材目录

型材编号	图 例	型材编号	图 例	型材编号	图 例
名称		名称		名称	
壁厚T(mm)		壁厚T(mm)		壁厚T(mm)	
重量(kg/m)		重量(kg/m)		重量(kg/m)	
ZYT990A09-14		ZYT990A05-20		ZYT990A07-12	
固定框		上下方		勾企	
T=1.4		T=2.0		T=1.2	
0.726 kg/m		0.813 kg/m		0.606 kg/m	
ZYT990A09-20		ZYT990A05A-12		ZYT990A07-14	
固定框		上下方		勾企	
T=2.0		T=1.2		T=1.4	
1.011 kg/m		0.500 kg/m		0.691 kg/m	
ZYT990A11-12		ZYT990A05A-14		ZYT990A07-20	
中固		上下方		勾企	
T=1.2		T=1.4		T=2.0	
0.969 kg/m		0.560 kg/m		0.870 kg/m	
ZYT990A11-14		ZYT990A06-12		ZYT990A07A-12	
中固		光企		勾企	
T=1.4		T=1.2		T=1.2	
1.097 kg/m		0.565 kg/m		0.565 kg/m	
ZYT990A16-10		ZYT990A06-14		ZYT990A07A-14	
边封插板		光企		勾企	
T=1.0		T=1.4		T=1.4	
0.401 kg/m		0.639 kg/m		0.647 kg/m	
ZYT990A10-10		ZYT990A06-20		ZYT990A21	
插板		光企		单玻压线	
T=1.0		T=2.0		T=0.9	
0.418 kg/m		0.794 kg/m		0.131 kg/m	槽口: 8MM
ZYT990A05-12		ZYT990A06A-12		ZYT990A12-9	
上下方		光企		压线	
T=1.2		T=1.2		T=0.9	
0.543 kg/m		0.527 kg/m		0.126 kg/m	槽口: 13.3MM
ZYT990A05-14		ZYT990A06A-14		ZYT990A13-9	
上下方		光企		压线	
T=1.4		T=1.4		T=0.9	
0.609 kg/m		0.595 kg/m		0.120 kg/m	槽口: 21MM

ZYT990A系列推拉门窗型材目录

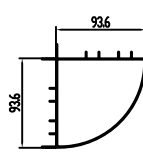
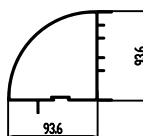
型材编号	图 例	型材编号	图 例	型材编号	图 例
名称		名称		名称	
壁厚T (mm)		壁厚T (mm)		壁厚T (mm)	
重量 (kg/m)		重量 (kg/m)		重量 (kg/m)	
ZYT990A26-9 压线 T=0.9 0.114 kg/m	 <p style="text-align: right; font-size: small;">未开模 槽口: 23MM</p>				
ZYT990A08-12 收口 T=1.2 0.147 kg/m					
ZYT990A04-14 90° 转角 T=1.4 1.445 kg/m	 <p style="text-align: right; font-size: small;">比例: 1: 2</p>				
ZYT990A25 90° 转角 T=1.4 1.526 kg/m	 <p style="text-align: right; font-size: small;">比例: 1: 2</p>				
ZYT990A14-10 纱窗 T=1.0 0.270 kg/m	